

Alva TT V2

Manual Generated: 12/12/2022 - 11:21

Table of Contents

Alva TT V2	3
Introduction	4
What's included with the Alva TT V2?	5
Top view	6
Rear view	7
Setting up the Alva TT V2	8
Getting connected	11
Operating instructions	14
Troubleshooting	15
Technical specifications	16

Alva TT V2

Last updated: July 14, 2022 06:00. Revision #7075

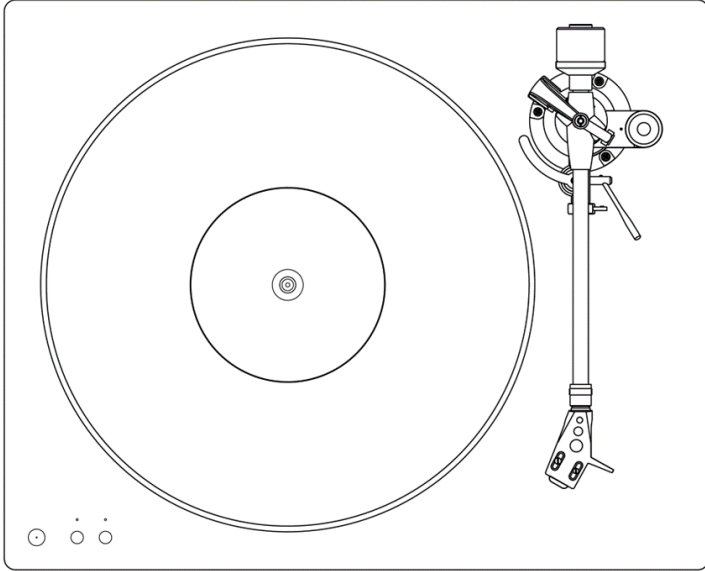

Users Manual

Introduction

Last updated: July 13, 2022 01:22. Revision #7083

This guide is designed to make installing and using this product as easy as possible. Information in this document has been carefully checked for accuracy at the time of printing; however, Cambridge Audio's policy is one of continuous improvement, therefore design and specifications are subject to change without prior notice.

This document contains proprietary information protected by copyright. All rights are reserved. No part of this manual may be reproduced by any mechanical, electronic or other means, in any form, without prior written permission of the manufacturer. All trademarks and registered trademarks are the property of their respective owners.

© Copyright Cambridge Audio Ltd

Qualcomm is a trademark of Qualcomm Incorporated, registered in the United States and other countries, used with permission. aptX is a trademark of Qualcomm Technologies International, Ltd., registered in the United States and other countries, used with permission.

Qualcomm aptX is a product of Qualcomm Technologies International, Ltd.

The Bluetooth® word mark and logos are registered trademarks owned by the Bluetooth SIG, Inc. and any use of such marks by Audio Partnership Plc is under license. Other trademarks and trade names are those of their respective owners.

For upcoming news on future products, software updates and exclusive offers, make sure you register your product at <http://www.cambridgeaudio.com/register>

What's included with the Alva TT V2?

Last updated: June 28, 2022 03:06. Revision #7082

Inside the box of your Alva TT V2 you will receive:

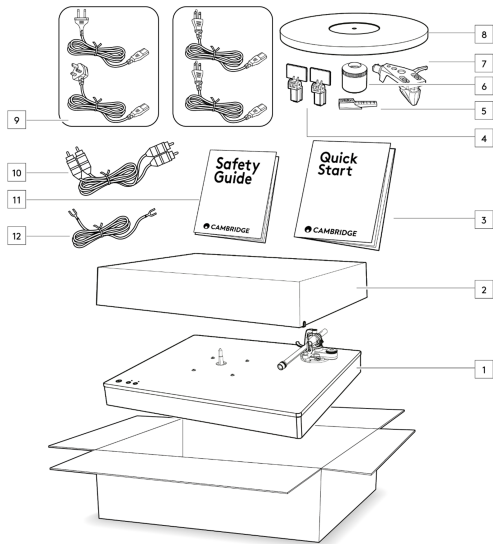

1. Alva TT V2 direct drive turntable.
2. Dust Cover.
3. Quick Start Guide.
4. 2 x Hinge Assembly.
5. Ortofon Stylus Gauge.
6. Counterweight.
7. Removable Headshell with Moving-Coil Cartridge.
8. POM Platter Assembly.
9. Region Specific Mains Leads.
10. RCA Cable.
11. Safety Guide.
12. Ground Lead.

Top view

Last updated: July 13, 2022 01:24. Revision #7081

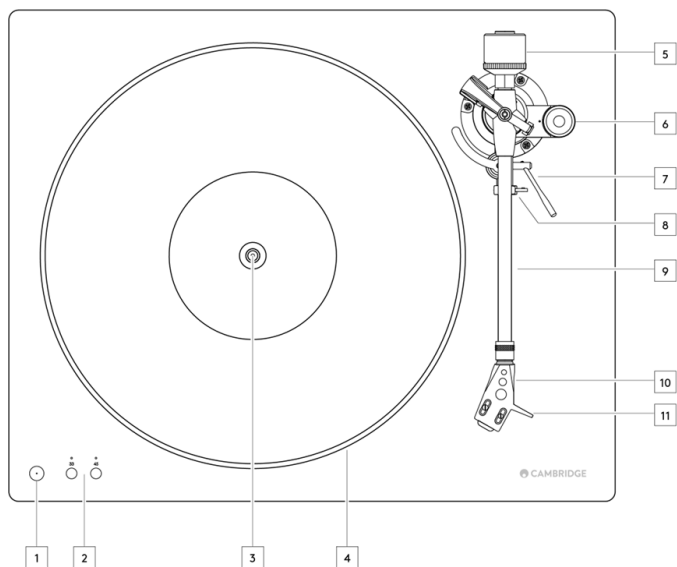

1. Standby/On - Switches the unit between standby (indicated by a dim LED) and on (indicated by a bright LED).

2. Start/Stop and Speed Selection Buttons - Use to start or stop platter rotation at either 33, or 45 RPM.

3. Drive Motor

4. Platter

5. Tonearm Counterweight - Used to adjust the stylus tracking force.

6. Anti-Skating Dial - Allows adjustment of the anti-skate function.

7. Tonearm Lift Lever - Used to gently lift and lower the tonearm.

8. Tonearm Rest and Clamp - Used to secure the tonearm when not in use.

9. Tonearm

10. Moving Coil Cartridge

11. Headshell with Finger lift

Rear view

Last updated: July 13, 2022 01:25. Revision #7080

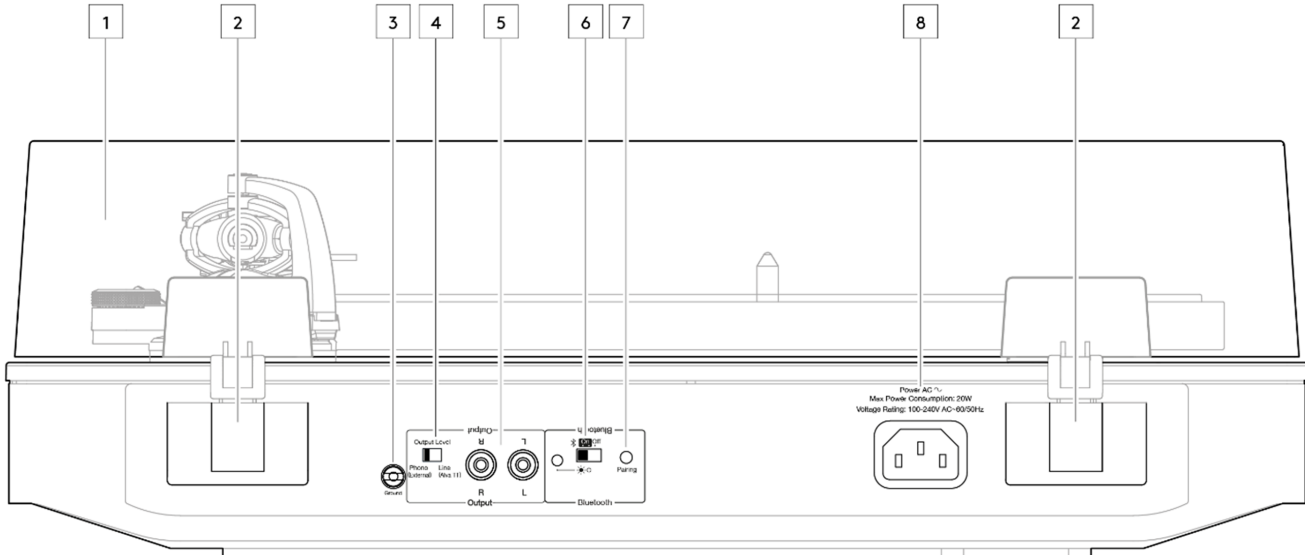

1. Lid

2. Lid hinges

3. Ground Connection Screw

4. Output Level Switch - Select between line level, or phono level output.

Line: With the switch set to 'Line' the internal phono stage will be used.

Phono: With the switch set to 'Phono', an external phono stage will need to be used.

5. Signal Output Sockets

6. Bluetooth Status with LED ON/OFF Switch

7. Bluetooth Pairing Button

8. AC Power Socket

Setting up the Alva TT V2

Last updated: June 28, 2022 03:06. Revision #7079

Once you have unboxed your turntable, please remove all the separate components in preparation for assembly.

1. Gently place the platter on the turntable.

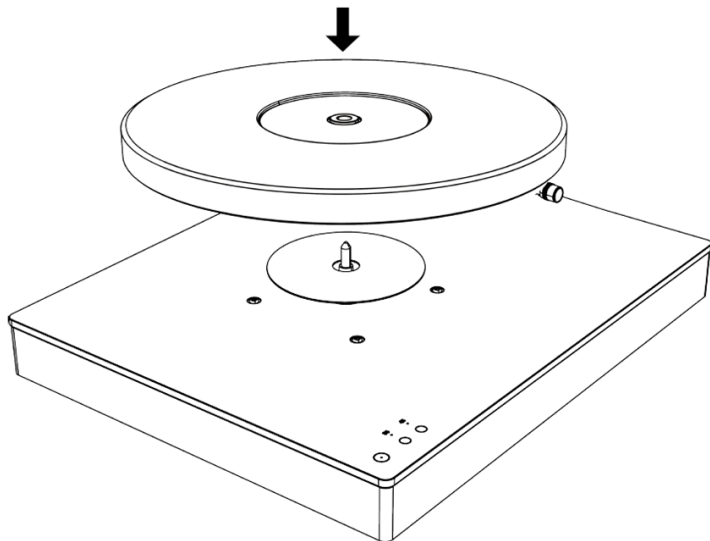

2. Push and rotate the counterweight onto the end of the tonearm, and then carefully install the headshell and cartridge assembly.

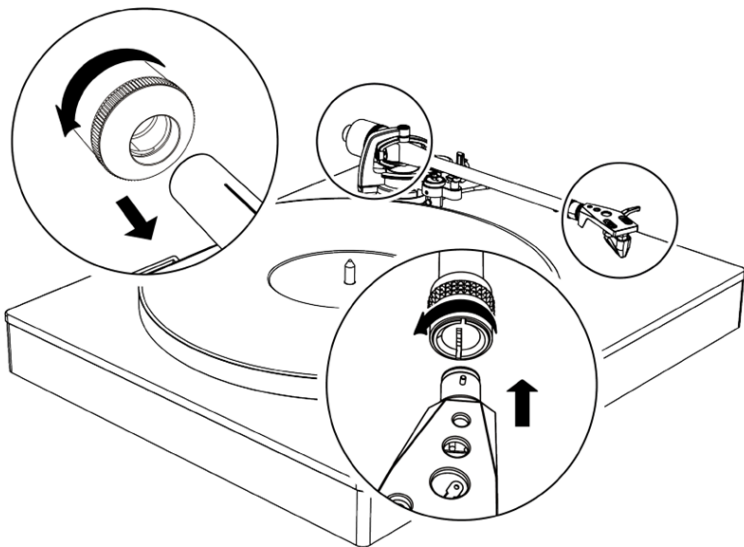

3. Place the slipmat onto the platter, release the tonearm from its rest and remove the stylus guard. Ensure the anti-skating dial is set to '0'.

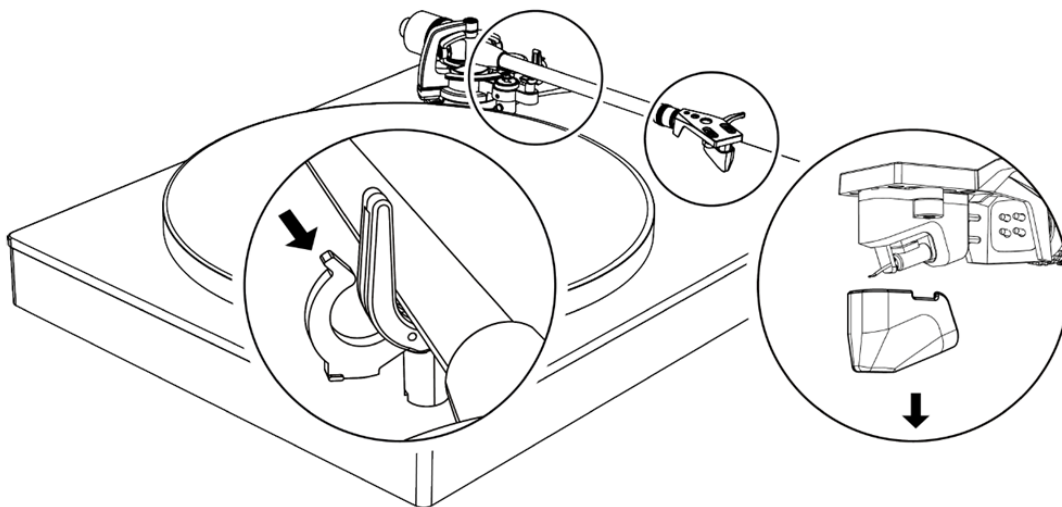

4. Place the stylus tracking force gauge onto the platter and carefully lower the stylus onto '2'.

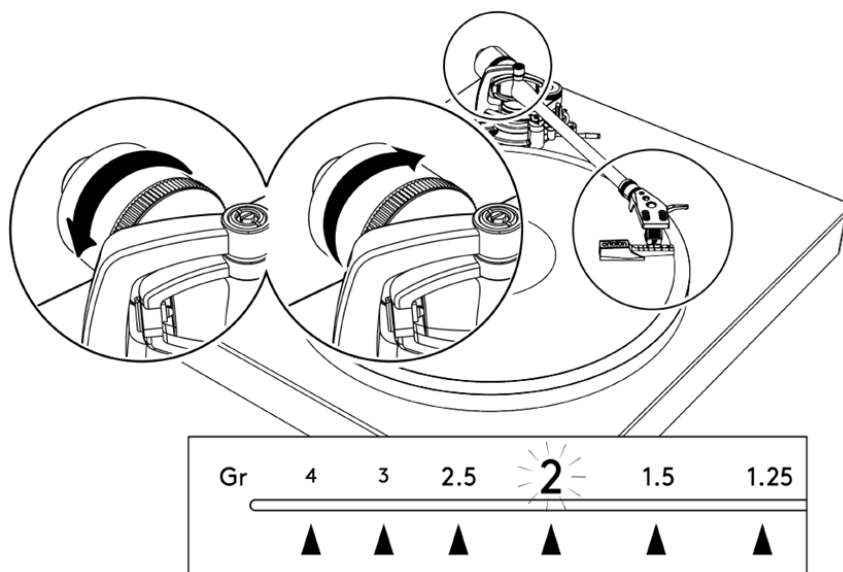

Ensuring that the tracking force is set correctly is important to the performance of your turntable and helps to minimise damage to your records.

To adjust the counterweight, return the tonearm to its rest. Rotate anti-clockwise to increase the balance weight and rotate clockwise to decrease the balance weight. This process requires care and patience to balance the cartridge properly.

Adjust the counterweight until the stylus force gauge is in balance, and then return the tonearm to its rest. Set the anti-skating dial to '2', matching the cartridge tracking force.

5. Connect the hinges to the turntable and insert the lid.

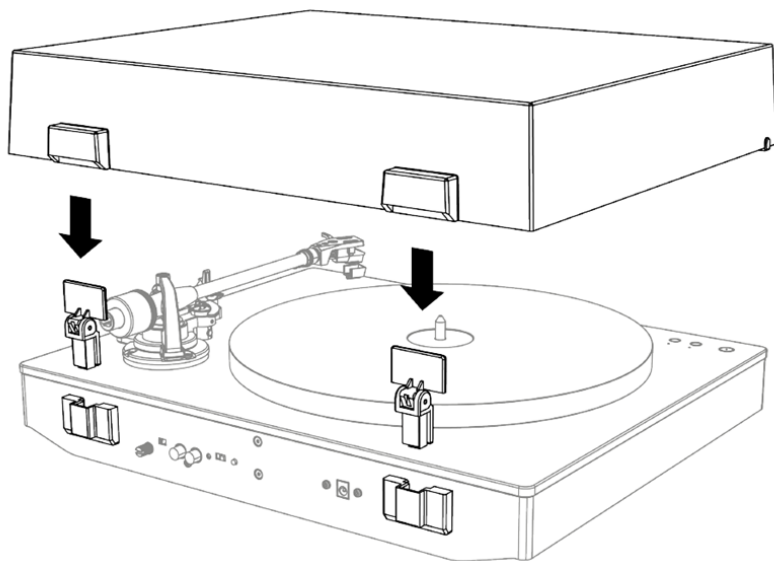

Getting connected

Last updated: July 13, 2022 01:26. Revision #7078

Analogue Audio Connections

Line Level Connection

1. Switch the 'output level switch' to 'line'.
 2. Using high-quality RCA interconnects, connect the audio output of the Alva TT V2 to a line-level input on your amplifier.
- Note:** Do not connect to an external phono-stage, or phono-level input with the turntable set to 'line'.

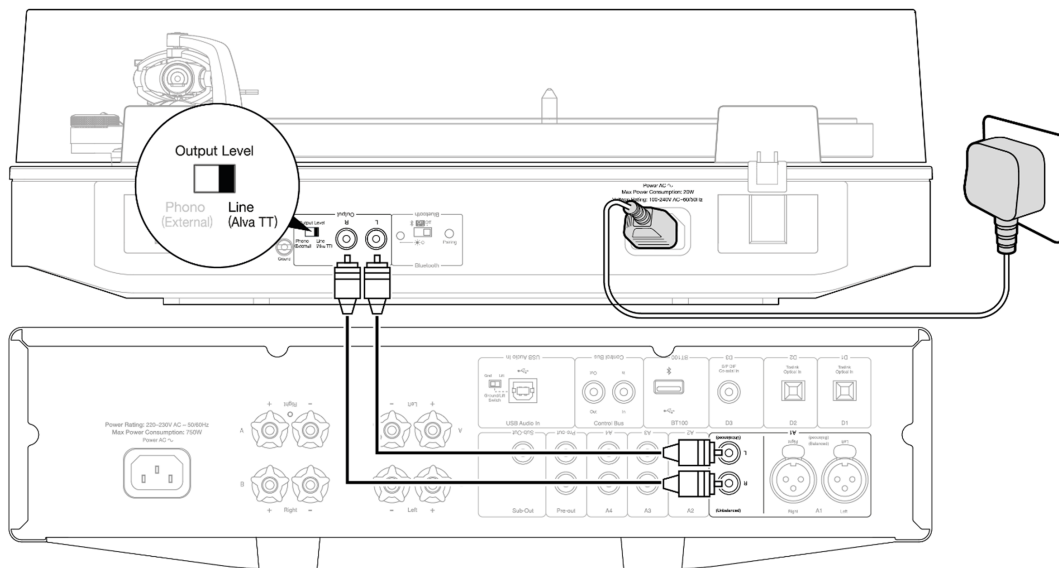

Phono Connection

1. Switch the 'output level switch' to 'phono'.
2. Connect a ground lead to the ground connection screw on the Alva TT V2, and the equipment that it is being connected to.
3. Using high-quality RCA interconnects, connect the audio output of the Alva TT V2 to the phono input of your external phono-stage, or amplifier.

Note: Do not connect to a line-level input with the turntable set to output at phono-level.

Note: Your external phono-stage, or phono input on your amplifier **MUST** be suitable for use with moving coil (MC) cartridges.

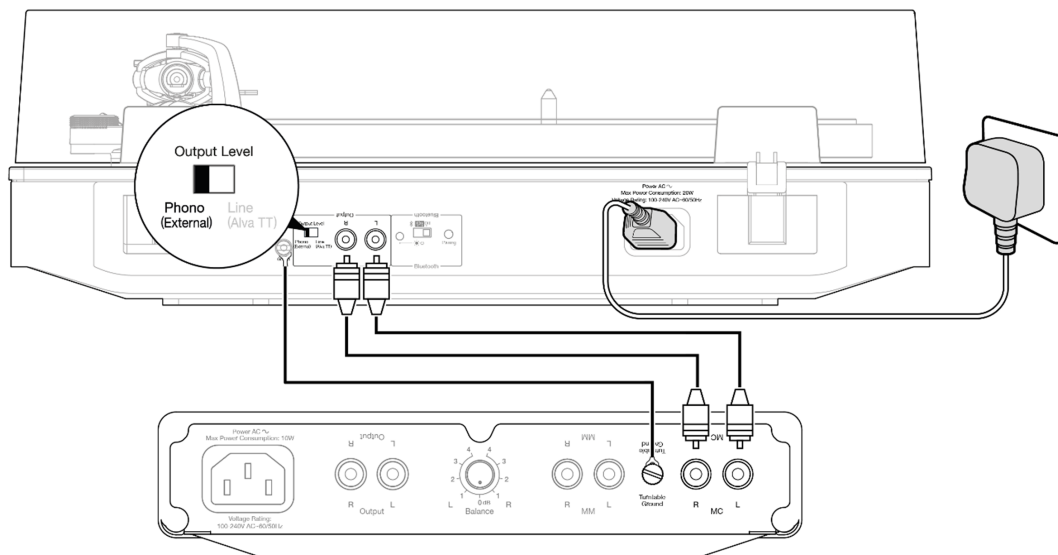

Bluetooth Connection

Pairing:

1. Make sure BT switch is set to ON.
2. Press and hold the Pairing button for 2 seconds to enter pairing mode.
3. If you haven't connected your turntable to a Bluetooth device previously, make sure your Bluetooth device is set to pairing mode (see your Bluetooth device instructions for how to do this).
4. Make sure that there are no other Bluetooth devices in pairing mode near the turntable, such as portable speakers, laptops, or smart TVs.
5. The turntable will automatically pair to your Bluetooth device.
6. Press and hold the Pairing button for 10 seconds to clear connections and turn off Bluetooth.

Note: By default, the Bluetooth will attempt to connect to the last paired device every time the unit is turned on.

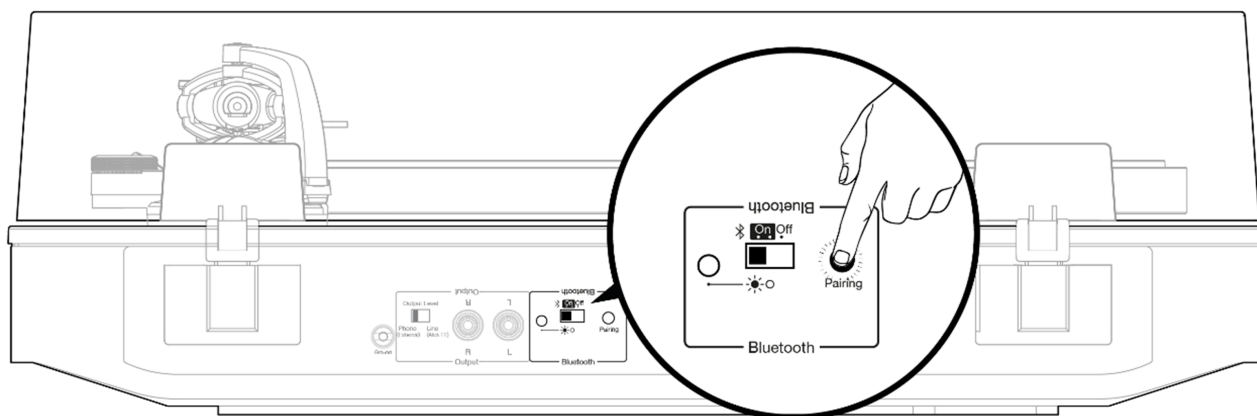

Bluetooth LED Status

Fast flashing - In pairing mode.

Slow flashing - Searching for the last paired device.

Solid - Paired to a device.

Long solid intervals - Paired to a device using aptX/aptX HD codec.

Operating instructions

Last updated: July 13, 2022 01:30. Revision #7077

Playing Records

1. Place your record over the spindle and onto the platter, then press the power button on the top panel.
2. Press required platter rotation speed button (33 or 45) on the top panel.
3. Raise the tonearm by moving the lift lever towards the rear of the turntable.
4. Position the tonearm over the desired location (groove) on the record.
5. Lower the tonearm slowly by moving the lift lever towards the front of the turntable.

Ending Play

1. Lift the tonearm with the lift lever.
2. Move the tonearm back onto the tonearm rest.
3. Secure the tonearm with the tonearm clamp.
4. Press the platter speed button to stop the platter rotation.
5. Press the power button to enter standby.

Auto Power Down (APD)

The Alva TT V2 comes set up with Auto Power Down (APD) enabled and will automatically switch to standby mode after 20 minutes of inactivity.

To disable APD: Press and hold the power button for 5 seconds when in standby.

To re-enable APD: Hold down the power button when plugging the mains power cable into the turntable.

Note: APD is automatically disabled when Phono output is selected.

Troubleshooting

Last updated: June 28, 2022 03:06. Revision #7076

No sound through both channels.

- Check that the amplifier is turned on.
- Ensure that the correct input source is selected on the amplifier.
- Confirm that all connections between the amplifier and turntable are secure.
- Check that the stylus is making sufficient contact with the record.
- Check that the connections between the amplifier and loudspeakers are secure.

There is a distorted or inconsistent sound.

- Check the setting of the internal preamp and ensure that the turntable is connected to the correct amplifier input.
- Check that the record is playing at the correct speed.
- Confirm that your tracking force is set correctly using a stylus force gauge. Match the anti-skate value to this measurement.
- Check the ground wire connection to be solid if output level switch is set to 'Phono'.
- Check the condition of the record and stylus.
- Ensure that the turntable is sat level, and isn't picking up any external vibrations.

Stylus skips across the record.

- Check that the stylus guard has been removed.
- Confirm that your tracking force is set correctly using a stylus force gauge. Match the anti-skate value to this measurement.
- Check the condition of the record.
- Ensure that the turntable is sat level and isn't picking up any external vibrations.
- Check the condition of the stylus.

Turntable will not connect to a Bluetooth playback device.

- Ensure that the turntable and device are not too far apart.
- Check that the device is in pairing mode.
- Check that the turntable is in pairing mode.

Turntable is connecting to an incorrect Bluetooth playback device.

- Disable/switch off all other Bluetooth devices.
- Clear all paired devices on the turntable.

Inconsistent sound or playback whilst listening via Bluetooth.

- Check that the Bluetooth signal is not being blocked or interrupted.
- Bring the Bluetooth playback device closer to the turntable.

Technical specifications

Last updated: July 13, 2022 02:26. Revision #7084

Turntable

Turntable Type

Direct Drive

Turntable Speeds

33 1/3, 45 RPM

Torque

1.6kg/cm

Wow and Flutter

<0.1%

Platter Material

POM (Polyoxymethylene)

Platter Diameter

305mm

Tonearm

Type

Static balanced tonearm with removable headshell

Effective Length

221.5mm

Overhang

19mm

Effective Mass

19.6g

Internal Phono Stage

Gain @ 1kHz

42dB

Nominal Output (supplied cartridge)

250m VRMS

Equivalent Input Noise (A weighted)

0.1u VRMS

RIAA Curve Accuracy

+/- 0.3dB 30Hz-20kHz

Signal/Noise Ratio (Ref 1V OUT, 20-20k BW)

>90dB

THD+N 1kHz

0.0025%

Input Impedance

47kΩ

Input Capacitance

330pF

Outputs

Audio Output

RCA phono/line level (switchable)

Bluetooth

SBC/aptX/aptX HD

General

Power Supply

AC 100-240V, 50/60Hz

Power Consumption

5.5W approx, 20W max, <0.25W (Standby)

Dimensions (W x H x D)

435 x 139 x 368 mm

Weight

10.9kg

Cartridge

Type

High output moving coil

Frequency Response

+/- 1dB 30Hz-20kHz

Stylus

Elliptical

Cantilever

Aluminium

Output Level

2mV @ 1kHz

Recommended Tracking Force

2g

Recommended Load

47k Ω